

정면도

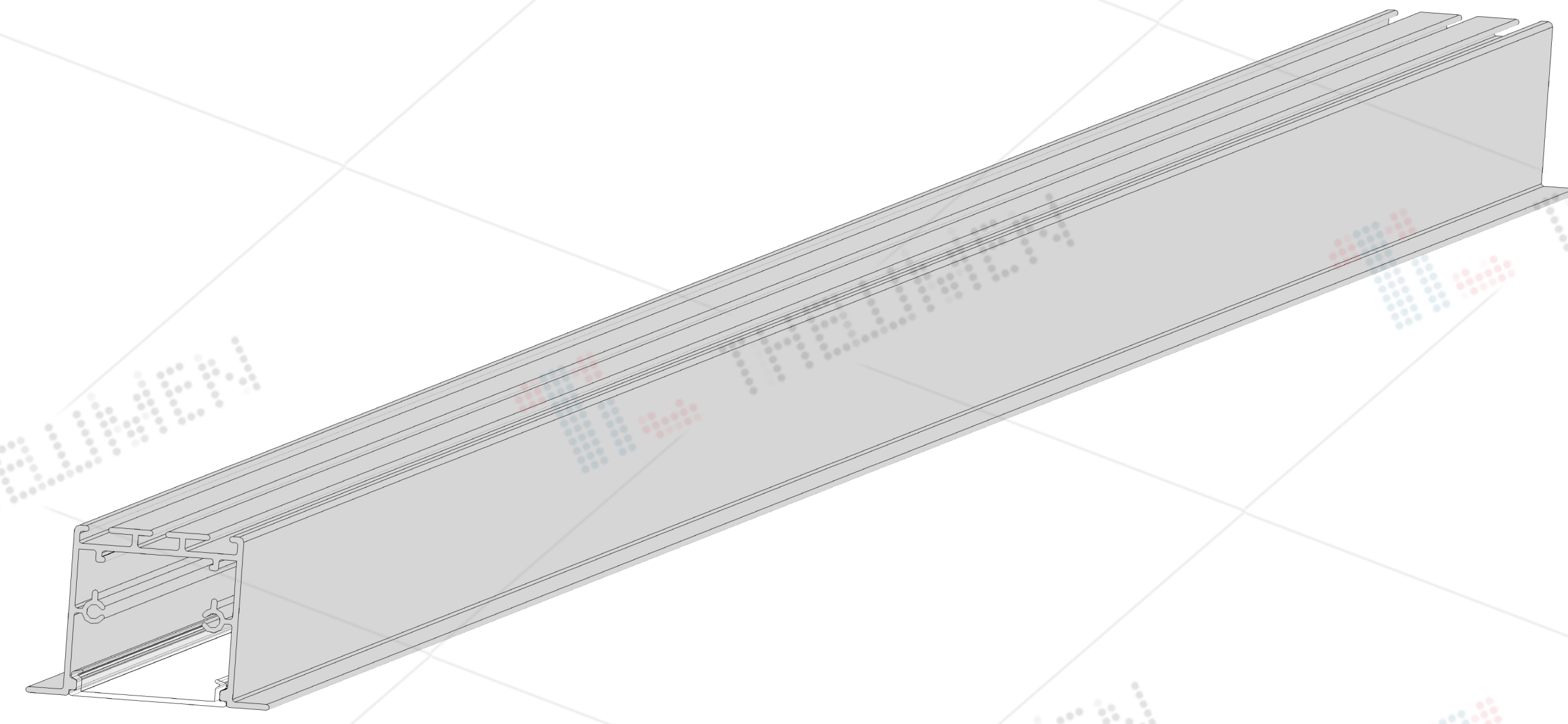

3D VIEW

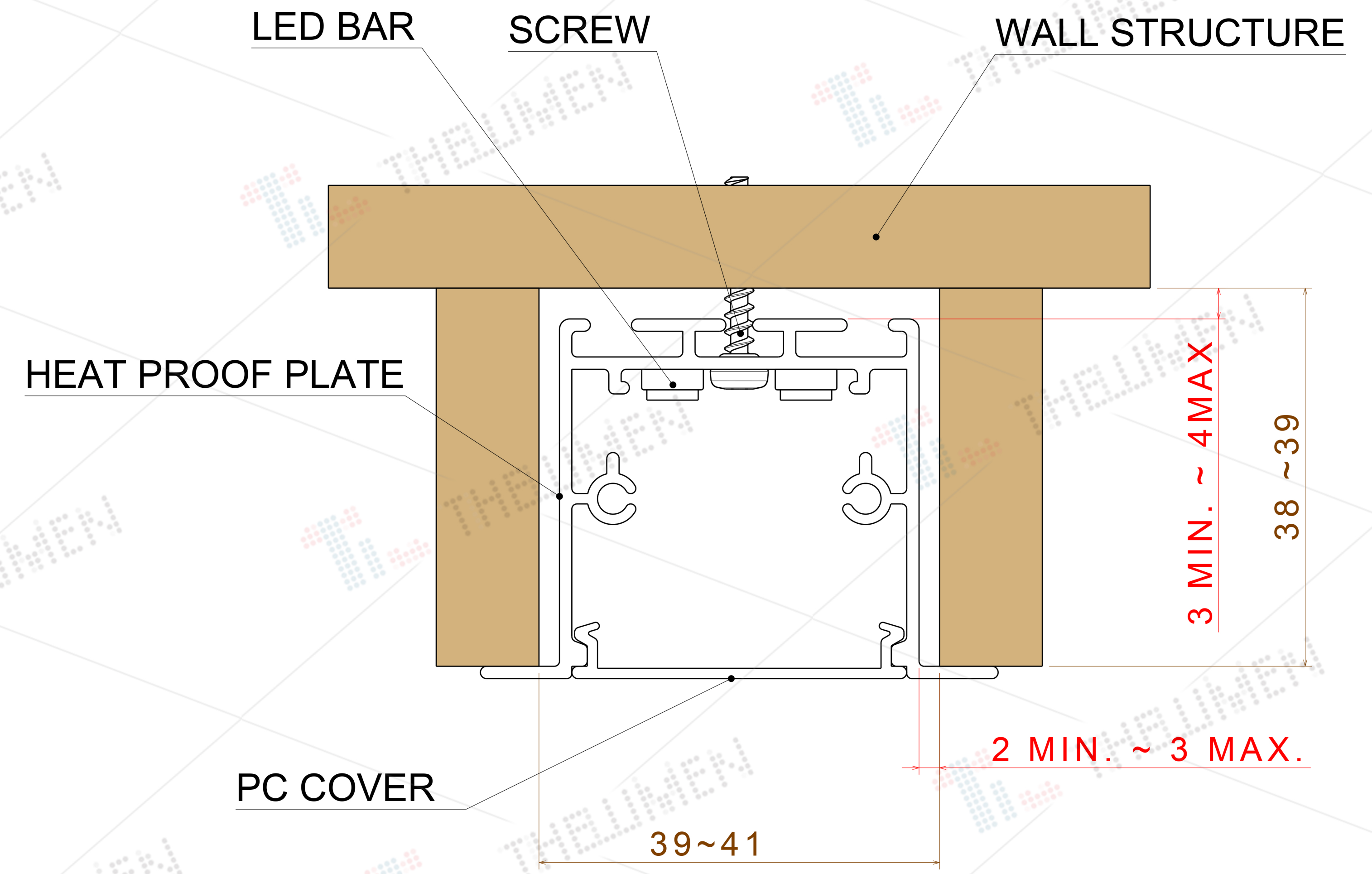

조립 부품 명칭

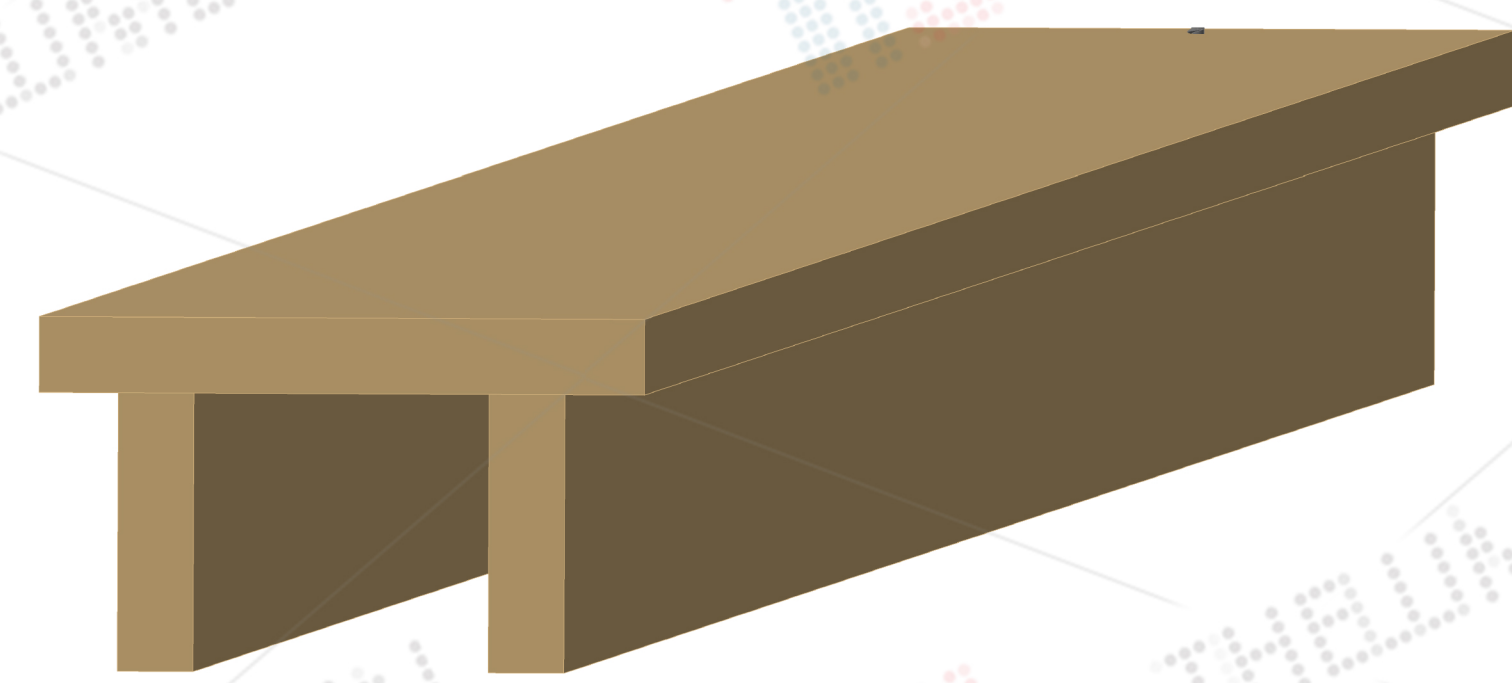

① 치수에 맞게 가벽 설치

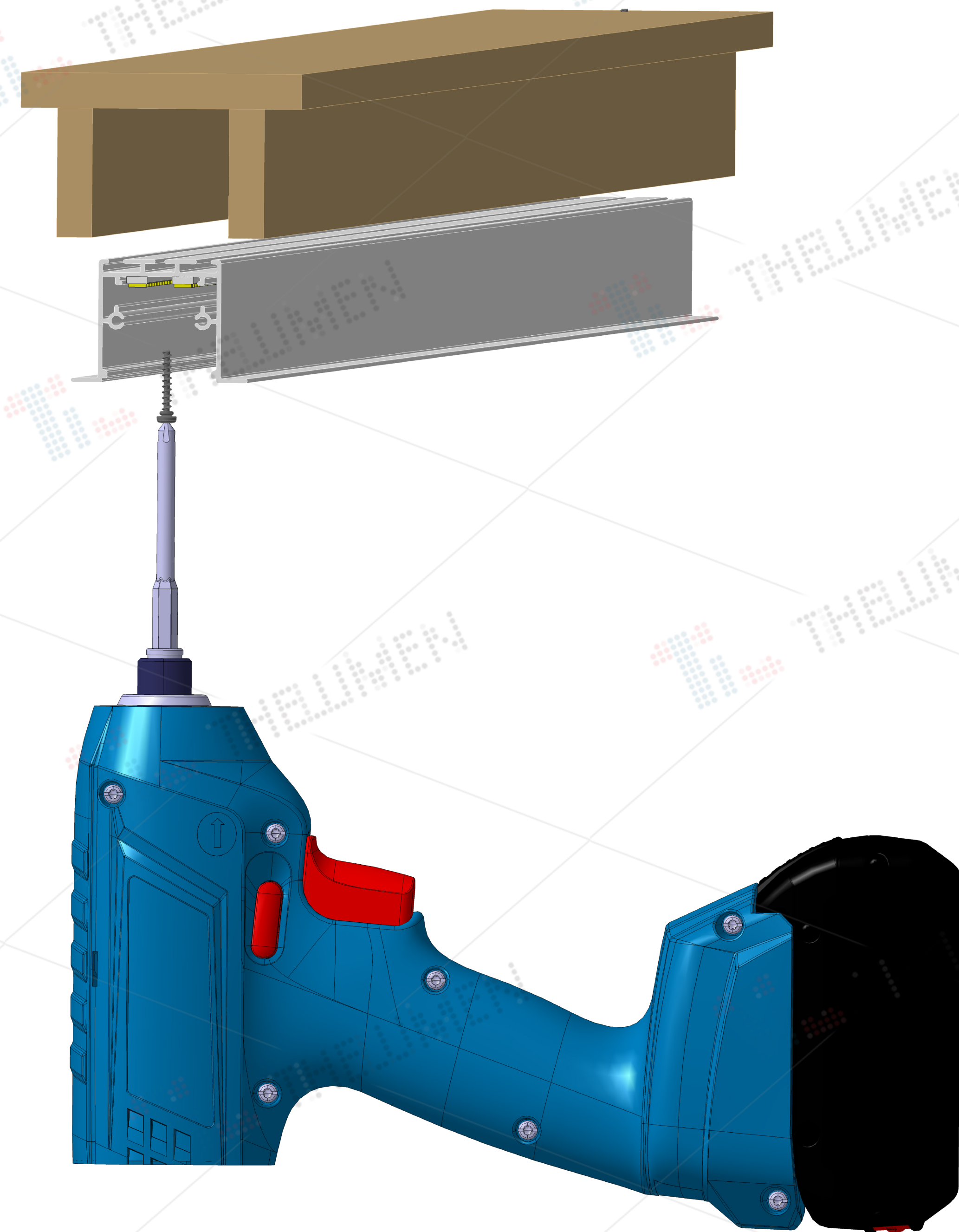

② HEAT PROOF PLATE와 가벽에 스크류 체결

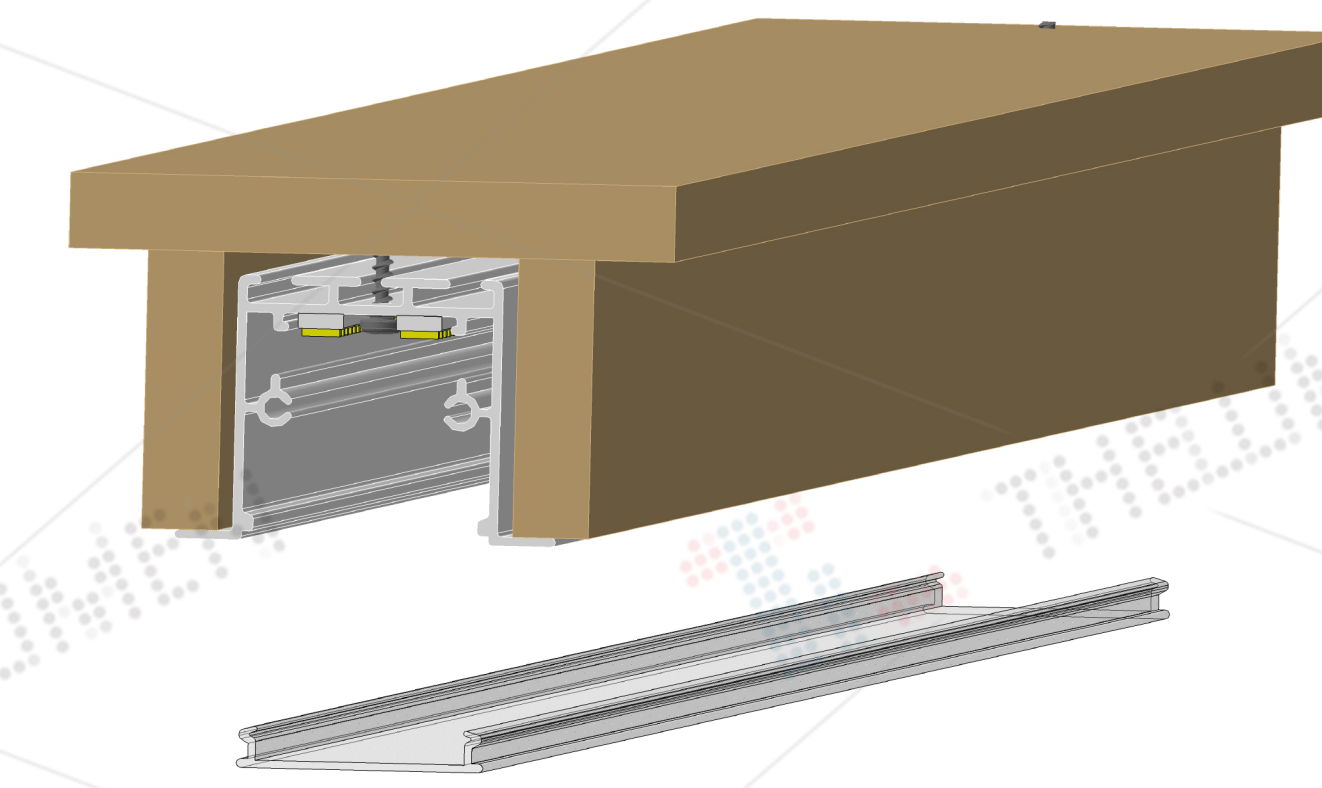

③ PC COVER 조립

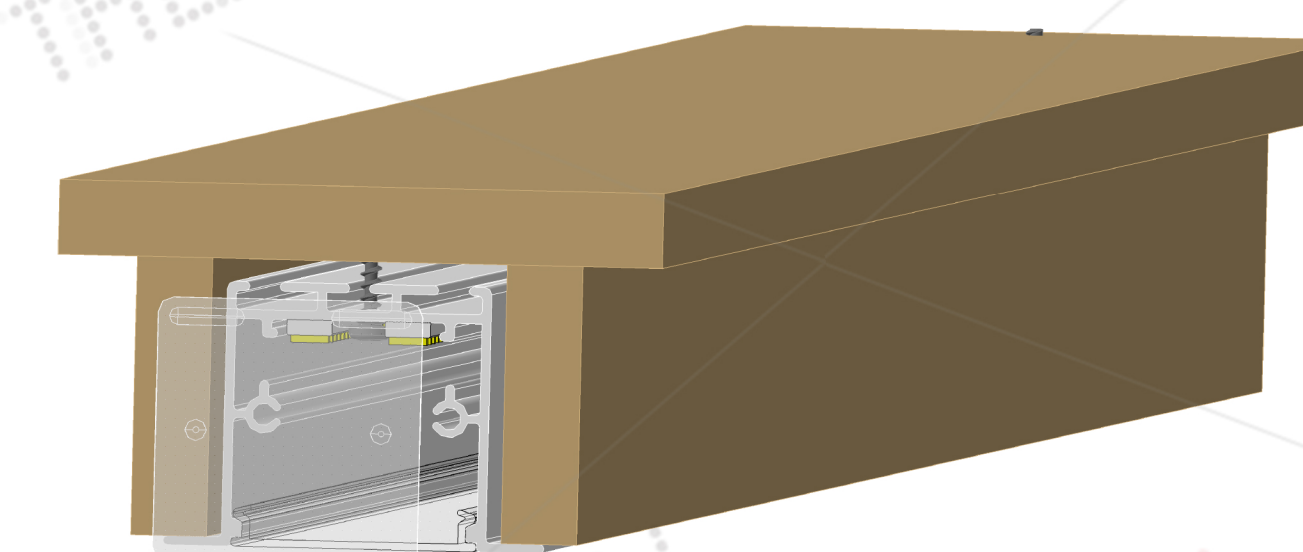

④ 마개 조립

<small>This drawing is our property. It can't be reproduced or communicated without our written agreement.</small>			
DRAWN BY	DATE	DRAWING TITLE	
J.Y.KIM	2018-05-06	TL3535-W	
CHECKED BY	DATE	SIZE	DRAWING NUMBER
-	-	A0	3535-0010
APPROVED BY	DATE	SCALE	WEIGHT(kg)
K.G.HAN	2018-05-06	(1:1)	-
		SHEET	1/1